

Description

The DFM1851D5 is an uni-directional TVS diode, utilizing leading monolithic silicon technology to provide fast response time and low ESD clamping voltage, making this device an ideal solution for protecting voltage sensitive data and power line. The DFM1851D5 complies with the IEC 61000-4-2(ESD) with $\pm 30\text{kV}$ air and $\pm 30\text{kV}$ contact discharge. It is assembled into an ultra-small SOD-523 lead-free package. The small size and high ESD surge protection make DC1851D5 an ideal choice to protect cell phone, digital cameras, audio players and many other portable applications.

Mechanical Characteristics

- ◆ Package: SOD-523
- ◆ Lead Finish: Matte Tin
- ◆ Case Material: "Green" Molding Compound.
- ◆ Moisture Sensitivity: Level 3 per J-STD-020
- ◆ Terminal Connections: See Diagram Below
- ◆ Marking Information: See Below

Dimensions and Pin Configuration

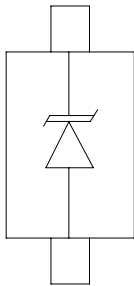

Circuit and Pin Schematic

Features

- ◆ 300W peak pulse power (8/20 μs)
- ◆ Protects one data or power line
- ◆ Ultra low leakage: nA level
- ◆ Operating voltage: 18V
- ◆ Ultra low clamping voltage
- ◆ Complies with following standards:
 - IEC 61000-4-2 (ESD) immunity test
 - Air discharge: $\pm 30\text{kV}$
 - Contact discharge: $\pm 30\text{kV}$
 - IEC61000-4-4 (EFT) 40A (5/50ns)
 - IEC61000-4-5 (Lightning) 6A (8/20 μs)
- ◆ RoHS Compliant

Applications

- ◆ Cellular Handsets and Accessories
- ◆ Personal Digital Assistants
- ◆ Notebooks and Handhelds
- ◆ Portable Instrumentation
- ◆ Digital Cameras
- ◆ Peripherals
- ◆ Audio Players
- ◆ Keypads, Side Keys, LCD Displays

Marking Information

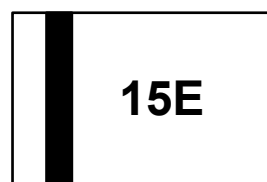

15E= Device Marking Code
Bar denotes Cathode

Ordering Information

Part Number	Marking	Packaging	Reel Size
DFM1851D5	15E	3000/Tape & Reel	7 inch

Absolute Maximum Ratings ($T_A=25^\circ\text{C}$ unless otherwise specified)

Parameter	Symbol	Value	Unit
Peak Pulse Power (8/20 μs)	Ppk	200	W
Peak Pulse Current (8/20 μs)	Ipp	6	A
ESD per IEC 61000-4-2 (Air)	VESD	± 30	kV
ESD per IEC 61000-4-2 (Contact)		± 30	
Operating Temperature Range	TJ	-55 to +125	$^\circ\text{C}$
Storage Temperature Range	Tstg	-55 to +150	$^\circ\text{C}$

Electrical Characteristics ($T_A=25^\circ\text{C}$ unless otherwise specified)

Parameter	Symbol	Min	Typ	Max	Unit	Test Condition
Reverse Working Voltage	VRWM			18	V	Pin 1 to Pin 2
Breakdown Voltage	VBR	20			V	IT = 1mA, Pin 1 to Pin 2
Reverse Leakage Current	IR			0.2	μA	VRWM = 18V, Pin 1 to Pin 2
Forward Voltage	VF			1.2	V	IF = 10mA, Pin 2 to Pin 1
Clamping Voltage	VC			24	V	IPP = 1A (8 x 20 μs pulse), Pin 1 to Pin 2
Clamping Voltage	VC			35	V	IPP = 6A (8 x 20 μs pulse), Pin 1 to Pin 2
Junction Capacitance	CJ		50		pF	VR = 0V, f = 1MHz

Typical Performance Characteristics (TA=25°C unless otherwise Specified)

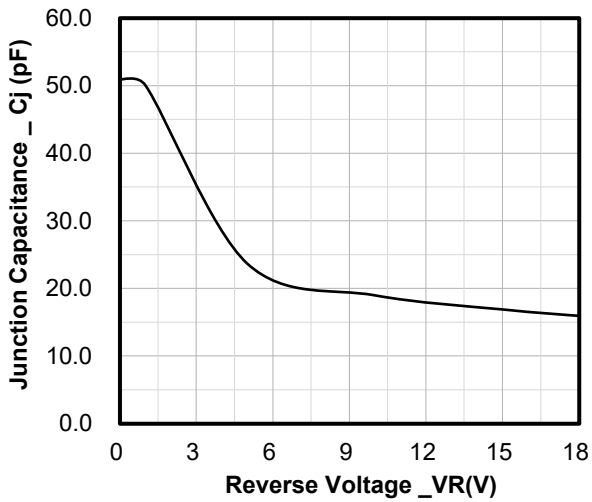

Junction Capacitance vs. Reverse Voltage

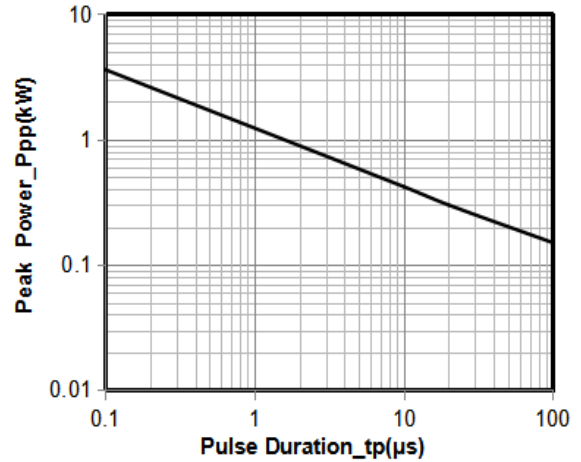

Peak Pulse Power vs. Pulse Time

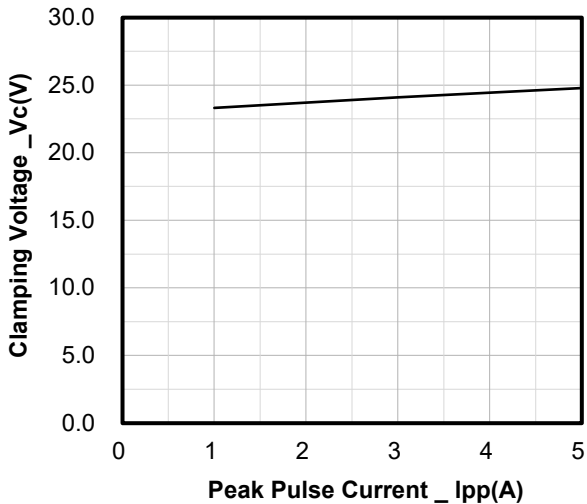

Clamping Voltage vs. Peak Pulse Current

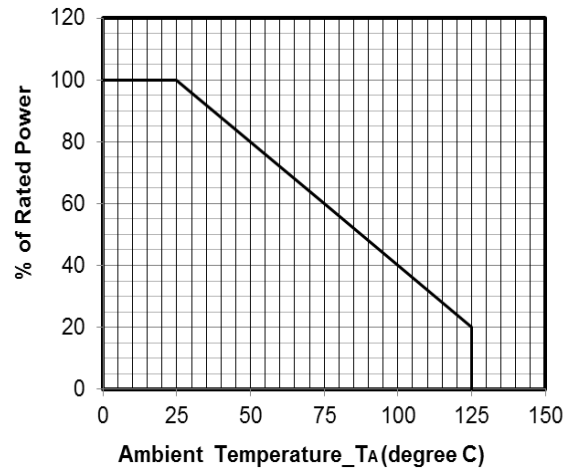

Power Derating Curve

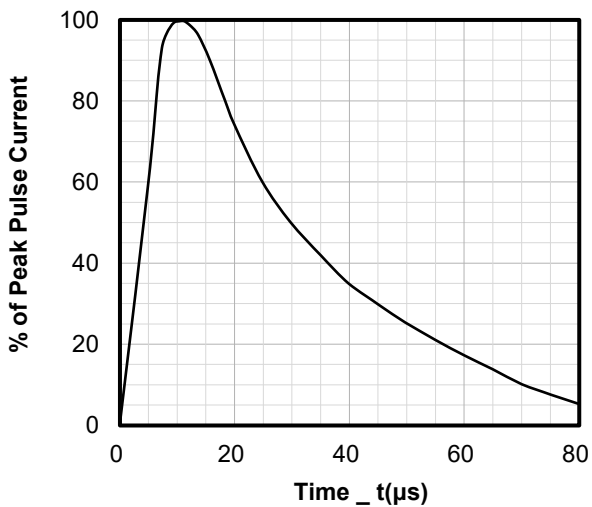

8 X 20μs Pulse Waveform

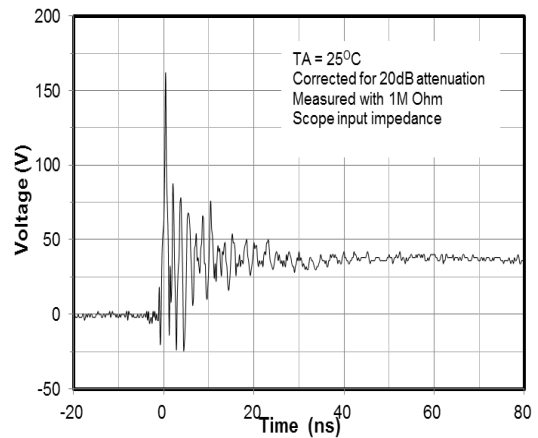

ESD Clamping Voltage

8 kV Contact per IEC61000-4-2

SOD-523 Package Outline Drawing

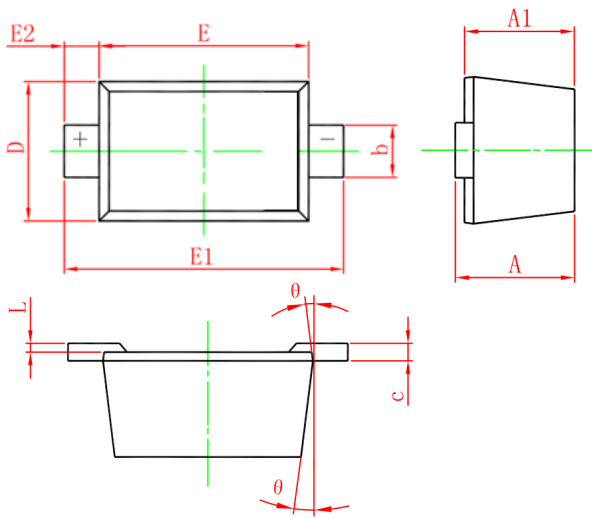

SYM	DIMENSIONS					
	MILLIMETERS			INCHES		
	MIN	NOM	MAX	MIN	NOM	MAX
A	0.51	--	0.77	0.020	--	0.031
A1	0.50	--	0.70	0.020	--	0.028
b	0.25	--	0.35	0.010	--	0.014
c	0.08	--	0.15	0.003	--	0.006
D	0.75	--	0.85	0.030	--	0.033
E	1.10	--	1.30	0.043	--	0.051
E1	1.50	--	1.70	0.059		0.067
E2	0.20REF			0.008REF		
L	0.01	--	0.07	0.001	--	0.003
Θ	7° REF			7° REF		

Suggested Land Pattern

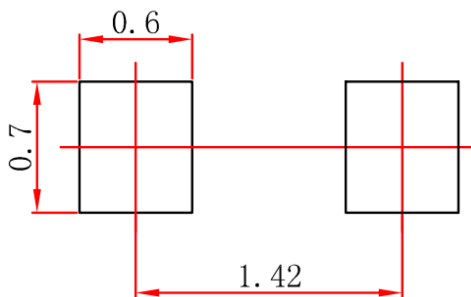

Unit : mm

Contact Information

Changzhou D-first Electronics CO.,Ltd.

www.first-electronic.com

Email: xhf@first-electronic.cn

Phone: +86 (0519) 8817 1671